

## MAGNETIC LED track light TOKYO "I" 20 W, TUYA Dimming Datasheet

Number of heads	1
Mounting	Track mounting
Lamps description	LED 20 W, CRI 90
Luminaire luminous flux	70 lm/W
Voltage (V)	48
Environment	Indoor
Notes	MAGNETIC track lights are a new generation of innovative lighting systems.

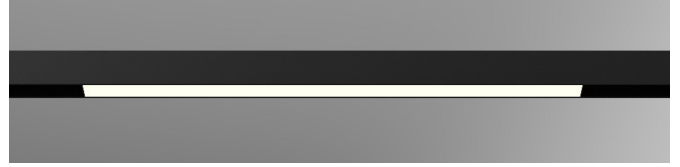

### OPTICAL

Aiming	Fixed
Light distribution symmetry	Symmetric
Beam angle	120°
Color temperature	2700K- 6000K

### ELECTRICAL

Wattage	20 W
Transformer mounting	Integral
Transformer type	Electronic
Frequency	50-60 HZ
Voltage	48 V

### PHYSICAL

Construction material	Aluminium, PVC
Weight (kg)	0,3
Luminaire lifespan	30 000h
LED module	OSRAM
Dimming	TUYA bluetooth app
Driver	Flicker free 48 V
Working temperature	0 to +40 °C
Warranty	2 years from purchase date

Magnetic LED light to be installed on 48 V magnetic track

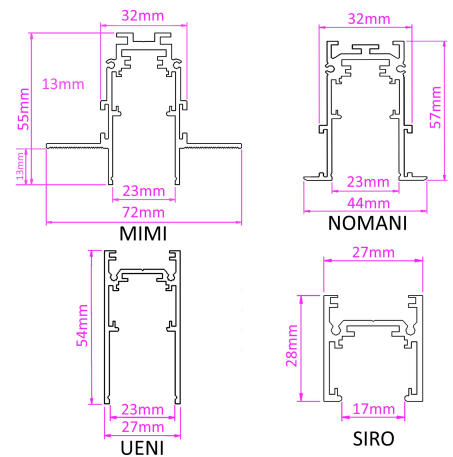

● Black    ● White

Dimensions: 605 x 25mm

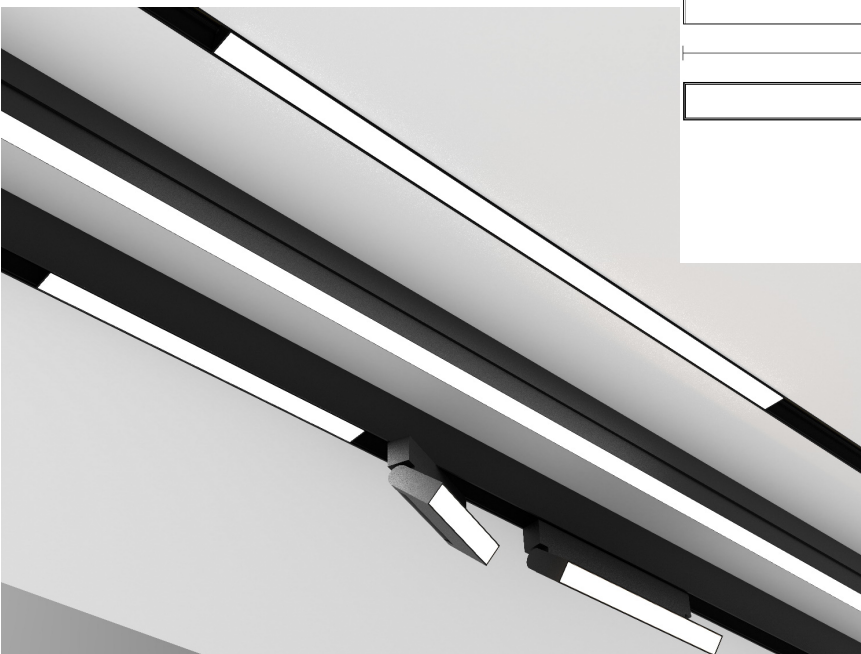
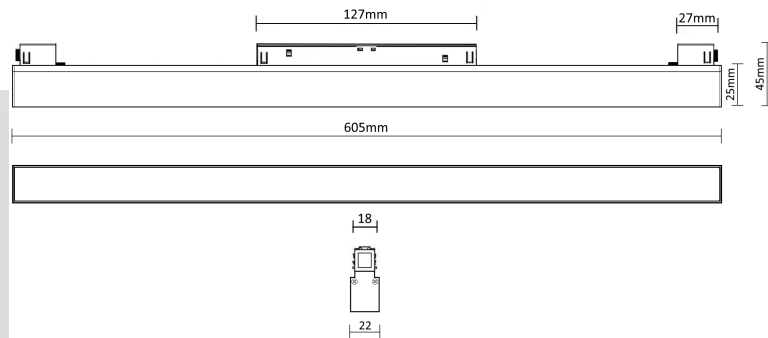

### CERTIFICATIONS

